



CATALOGO PRODOTTI

PRODUCTS CATALOGUE



## CONTROPUNTE ROTANTI REVOLVING LIVE CENTRES



**CONTROPUNTE ROTANTI PER TORNI;  
CONTROPUNTE CON CUSPIDE INTERCAMBIABILE;  
CONTROPUNTE A COMPRESSIONE;  
ATTACCHI VDI, CONO MORSE E CILINDRICO.**



**REVOLVING LIVE CENTRES FOR LATHES;  
LIVE CENTRES WITH INTERCHANGEABLE INSERT;  
PLUG-IN LIVE CENTRES;  
VDI, VICE TAPER AND CYLINDRICAL FITTINGS.**



**CHIA-MO SRL**  
VIA CADUTI DI SABBIONO, 12  
40011 ANZOLA DELL'EMILIA  
BOLOGNA ITALY

TEL +39 051734153  
FAX +39 051734958

WWW.CHIAMO.IT  
INFO@CHIAMO.IT



**CONTROPUNTA ROTANTE CON COMPRESIONE Tipo 172200**  
REVOLVING TAILSTOCK WITH COMPRESSION

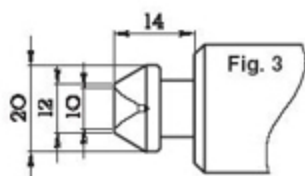
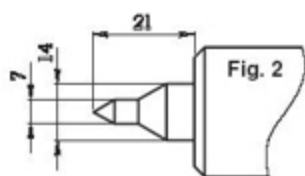
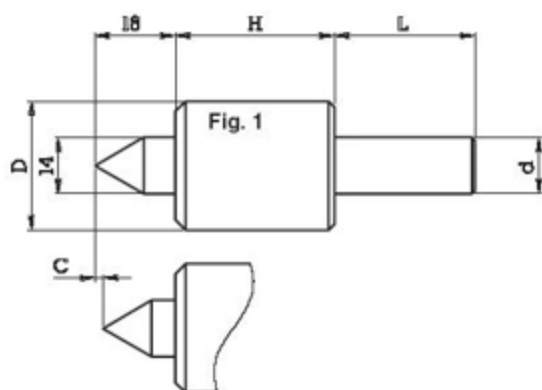

C = Corsa di compressione  
C = Absorber stroke

Code								Center
ART.			d	D	H	L	C	Punta
FIG. 1	FIG. 2	FIG. 3						
172.208 F1	172.208 F2	172.208 F3	8	32	39.5	35	2	60°
172.210 F1	172.210 F2	172.210 F3	10	32	39.5	35	2	60°
172.212 F1	172.212 F2	172.212 F3	12	32	39.5	35	2	60°
172.214 F1	172.214 F2	172.214 F3	14	32	39.5	35	2	60°
172.215 F1	172.215 F2	172.215 F3	15.875	32	39.5	35	2	60°
172.216 F1	172.216 F2	172.216 F3	16	32	39.5	35	2	60°
172.219 F1	172.219 F2	172.219 F3	19.05	32	39.5	46	2	60°
172.220 F1	172.220 F2	172.220 F3	20	32	39.5	46	2	60°
172.222 F1	172.222 F2	172.222 F3	22	32	39.5	46	2	60°
172.225 F1	172.225 F2	172.225 F3	25	32	39.5	46	2	60°
172.226 F1	172.226 F2	172.226 F3	25,40	32	39.5	46	2	60°





**CONTROPUNTA ROTANTE CON COMPRESSIONE Tipo 172300**

*REVOLVING TAILSTOCK WITH COMPRESSION*

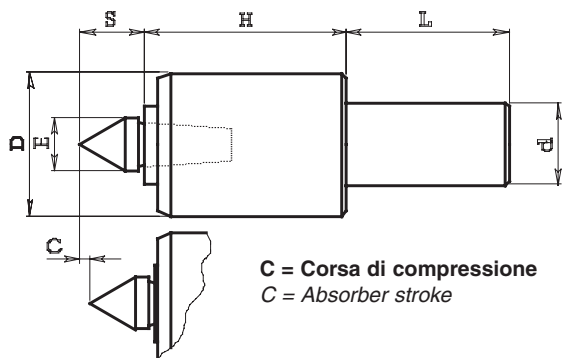

Code							
ART.	d	D	E	H	L	S	C
172.308	8	32	14	44	35	16	2
172.310	10	32	14	44	35	16	2
172.312	12	32	14	44	35	16	2
172.314	14	32	14	44	35	16	2
172.315	15.875	32	14	44	35	16	2
172.316	16	32	14	44	35	16	2
172.319	19.05	32	14	44	46	16	2
172.320	20	32	14	44	46	16	2
172.322	22	32	14	44	46	16	2
172.325	25	32	14	44	46	16	2
172.326	25.40	32	14	44	46	16	2

La contropunta viene fornita con cuspidi art. 172.301 - salvo diversa identificazione.  
*The revolving tailstock is provided with code 172.301 (interchangeable insert).*

**CUSPIDI INTERCAMBIABILI PER CONTROPUNTA**

*INTERCHANGEABLE INSERT*



Per articolo (for Code): 172.300

Code						Center
ART.	Fig.	E	S	G	F	Punta
172.301	1	14	16	-	-	60°
172.302	2	14	22	7	-	60°
172.303	3	20	12	12	10	60°

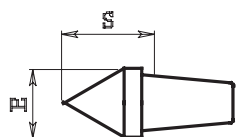

FIG. 1

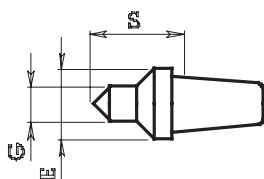

FIG. 2

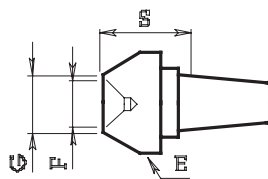
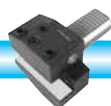

FIG. 3





**CONTROPUNTA ROTANTE CON COMPRESIONE Tipo 172400**

*REVOLVING TAILSTOCK WITH COMPRESSION*

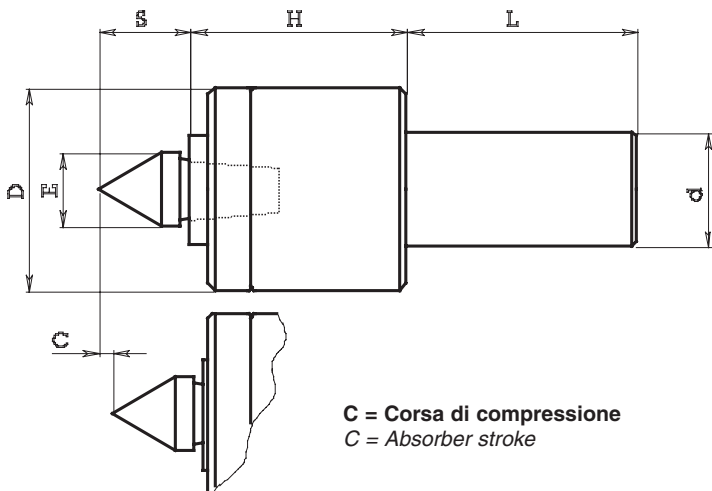

Code							
ART.	d	D	E	H	L	S	C
172.419	19.05	43	18	43	46	21	3
172.420	20	43	18	43	46	21	3
172.422	22	43	18	43	46	21	3
172.425	25	43	18	43	46	21	3
172.426	25.40	43	18	43	46	21	3
172.430	30	43	18	43	46	21	3
172.431	31.75	43	18	43	46	21	3
172.432	32	43	18	43	46	21	3
172.400 CM2	C.M.2	43	18	43	69	21	3
172.400 CM3	C.M.3	43	18	43	85	21	3

**CHIAVI PER ESTRAZIONE**  
**CUSPIDI ART. 172.411**  
*PULLER CODE 172.411*

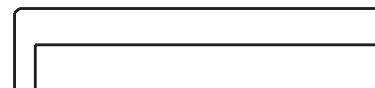

**N.B. La contropunta viene fornita con cuspidi art. 172.401**  
**- salvo diversa richiesta**  
*The revolving tailstock is provided with code 172.401*  
*(interchangeable insert)*

**CUSPIDI INTERCAMBIABILI PER CONTROPUNTA**

*INTERCHANGEABLE INSERT*

**Per articolo (for Code): 172.400**

Code					Center
ART.	Fig.	E	S	G	Punta
172.401	1	18	21	—	60°
172.401 090	1	18	28	—	90°
172.402	2	18	27	7	60°
172.402B	2	18	38	9	60°
172.403	3	30	21	14	60°
172.404	4	26	20	20	—

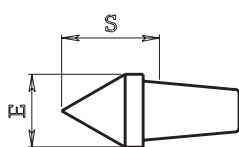
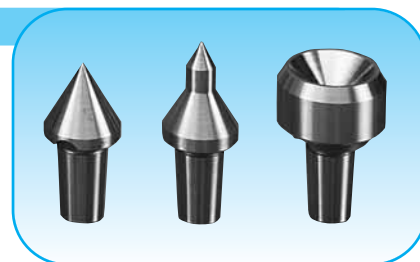

Fig. 1

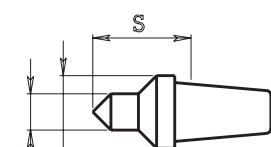

Fig. 2

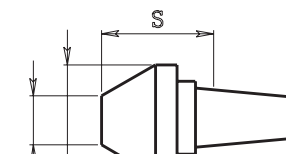

Fig. 3

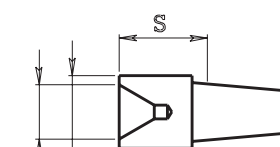
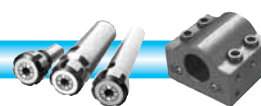
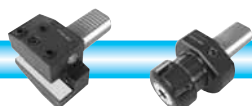

Fig. 4





**CONTROPUNTA ROTANTE CON COMPRESSIONE 600 Tipo 172**

REVOLVING TAILSTOCK WITH COMPRESSION

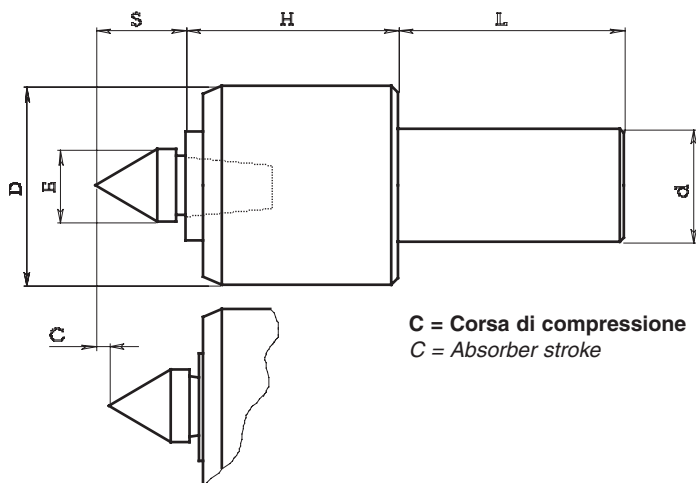

C = Corsa di compressione  
C = Absorber stroke



Code							
ART.	d	D	E	H	L	S	C
172.625	25	58	28	71	50	34	2,5
172.626	25.40	58	28	71	50	34	2,5
172.632	32	58	28	71	70	34	2,5
172.640	40	58	28	71	85	34	2,5
172.600 CM3	C.M.3	58	28	71	85	34	2,5
172.600 CM4	C.M.4	58	28	71	109	34	2,5

**N.B. La contropunta viene fornita con cuspidi art. 172.601**  
- salvo diversa richiesta  
The revolving tailstock is provided with code 172.601  
(interchangeable insert)

**CUSPIDI INTERCAMBIABILI PER CONTROPUNTA**

INTERCHANGEABLE INSERT

Per articolo (for Code): 172.600

Code					Center
ART.	Fig.	E	S	G	Punta
172.601	1	28	34	—	60°
172.602	2	28	40	7	60°
172.602B	2	28	40	12	60°
172.603	3	58	36	25	60°
172.604	4	28	32	24	—

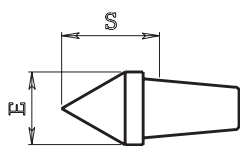
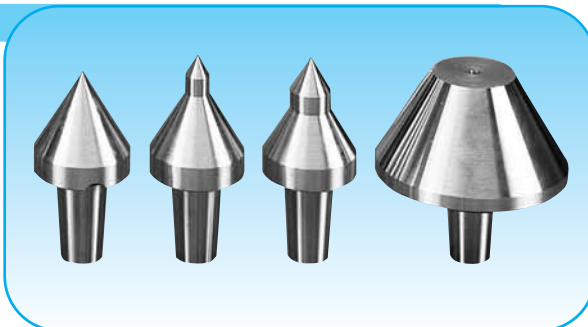

Fig. 1

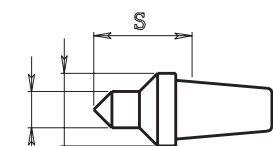

Fig. 2

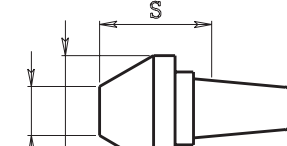

Fig. 3

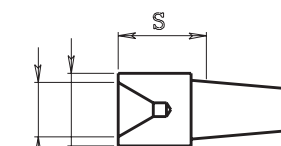
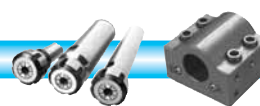
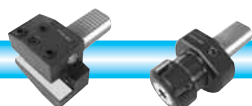
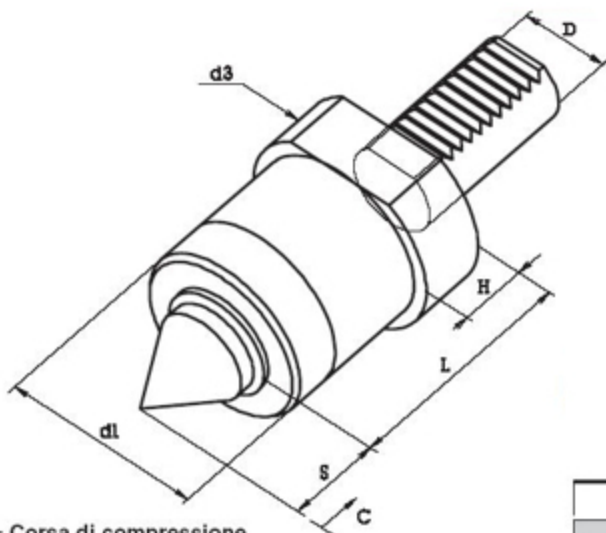

Fig. 4





**CONTROPUNTA ROTANTE CON COMPRESSIONE**  
*REVOLVING TAILSTOCK WITH COMPRESSION*



C = Corsa di compressione  
C = Absorber stroke

Code							
ART.	D	d1	d3	L	H	S	C
9 V3.30.78	30	58	68	78	20	34	2,5
9 V3.40.80	40	58	83	80	22	34	2,5

N.B. La contropunta viene fornita con cuspidi come Fig. 1 - Salvo diversa richiesta  
The revolving tailstock is provided with interchangeable insert Fig. 1

**CUSPIDI INTERCAMBIABILI PER CONTROPUNTA**  
*INTERCHANGEABLE INSERT*

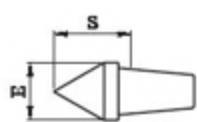

Fig. 1

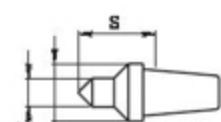

Fig. 2

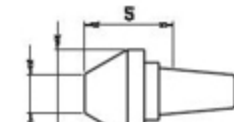

Fig. 3

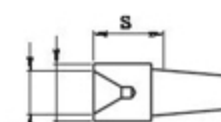
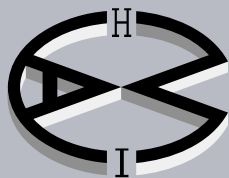
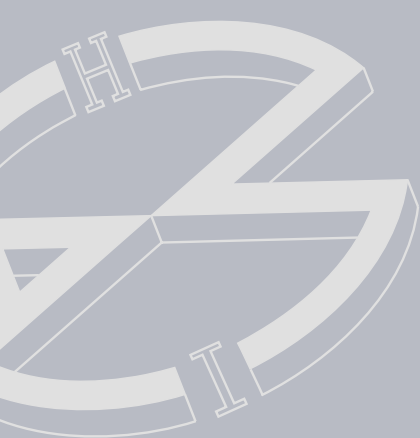

Fig. 4

Code				
ART.	Fig.	E	S	G
172.601	1	28	34	—
172.602	2	28	40	7
172.602 B	2	28	40	12
172.603	3	58	36	25
172.604	4	28	32	24





# CHIA-MO



## DOVE SIAMO WHERE WE ARE



**CHIA-MO**

Via Caduti di Sabbiuno, 12

40011 Anzola dell'Emilia (Bologna) Italy

Tel. +39 051 734153 - Fax +39 051 734958

info@chiamo.it - www.chiamo.it

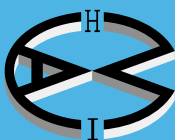

**CHIA-MO**  
ITALY



Via Caduti di Sabbiano, 12  
40011 Anzola dell'Emilia (Bologna) Italy  
Tel. +39 051 734153 - Fax +39 051 734958  
info@chiamo.it - www.chiamo.it

